

OBE Star

SAFETY NUT

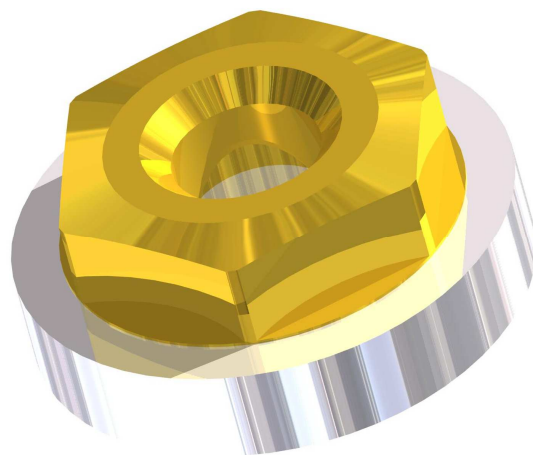
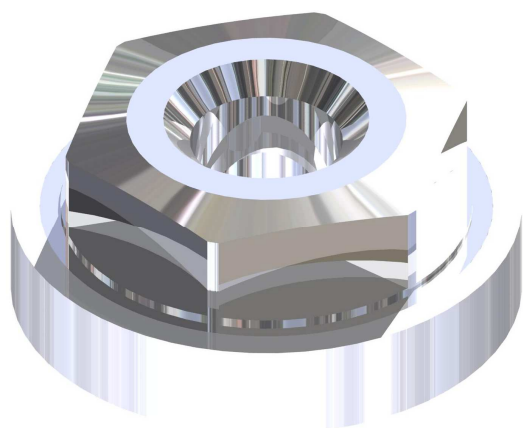

ACCESSORIES

OBE Star

SAFETY NUT

Injection Safety Nut for rimless frames

Features

- 3 products in one: nut + metal washer + plastic washer
- Made from stainless steel
- Injected with transparent plastic "Akulon"
- Available in two threads M1.2 and M1.4
- Patent pending

Benefits

- Easy handling
- 3 times faster assembling compared to standard systems
- Reduction of the risk of scratches on lens
- No need to deliver spare parts with each frame
- Flat design
- Re-usable system
- Anti loosening effect thanks to plastic inside the thread

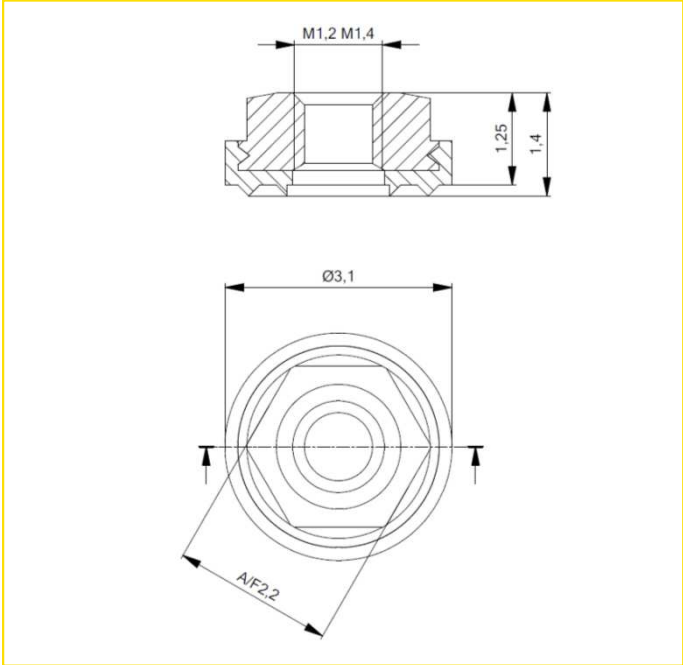
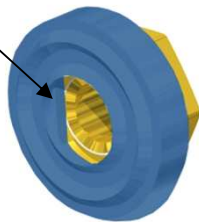

Part nos.

	Standard	Gold plated
M 1.2	93-02525.340.00	93-02525.340.60
M 1.4	93-02524.340.00	93-02524.340.60



90% of the recycled plastic sprues are used for injection of new safety nut

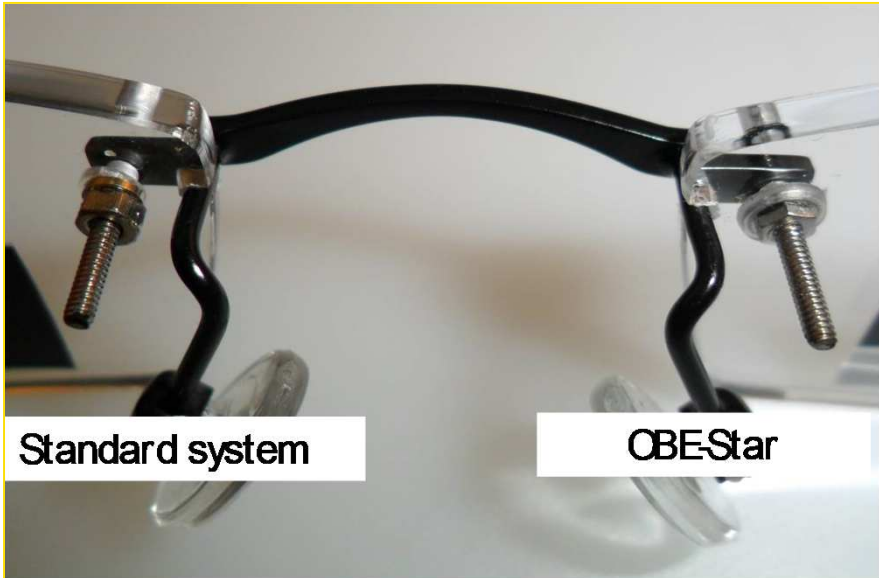

OBE Star

SAFETY NUT

The anti-loosening effect of OBE-star

OBE-Star

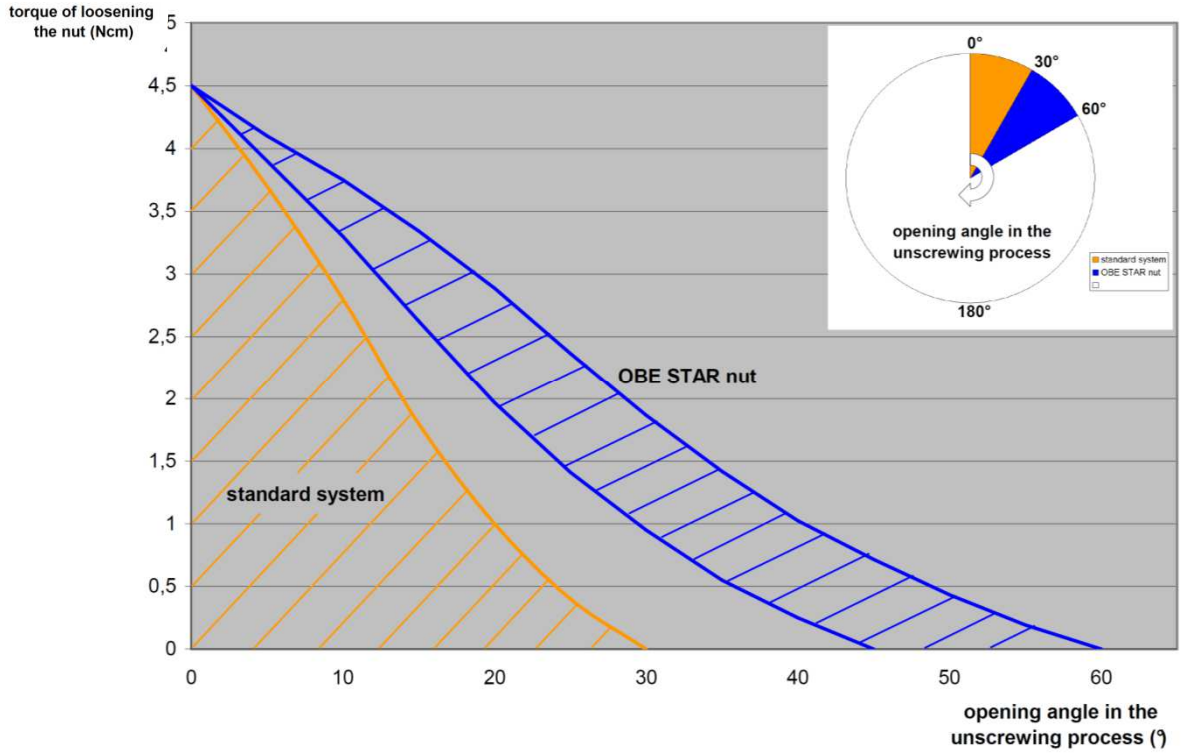
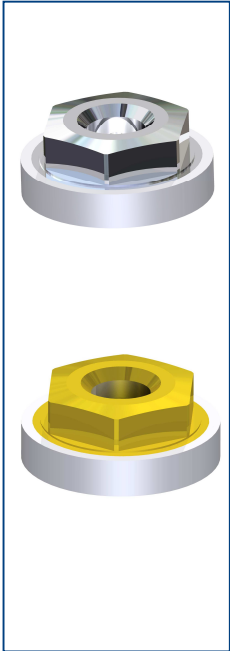

Standard system

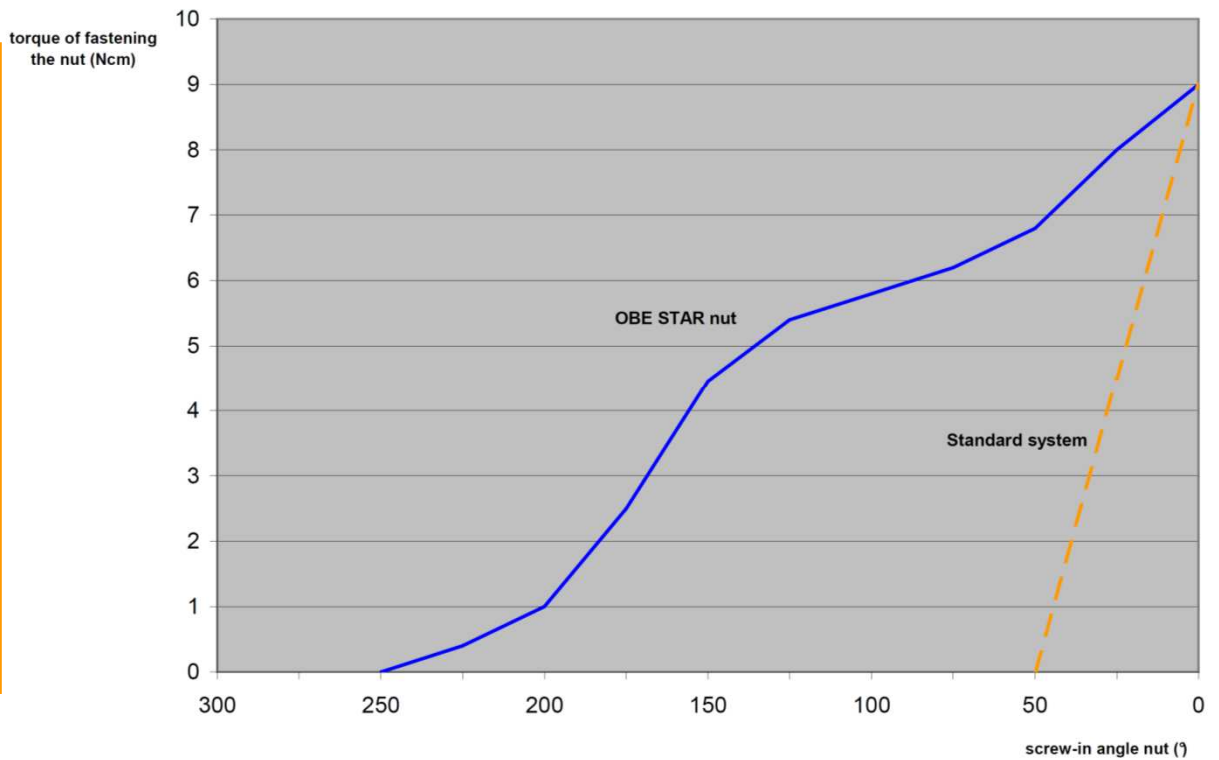



OBE GmbH & Co. KG · Turnstr. 22 · 75228 Ispringen · Germany
Tel. +49 7231 802-0 · www.obe.de · info@obe.de