

C'Flex

SLIDING SPRING HINGES

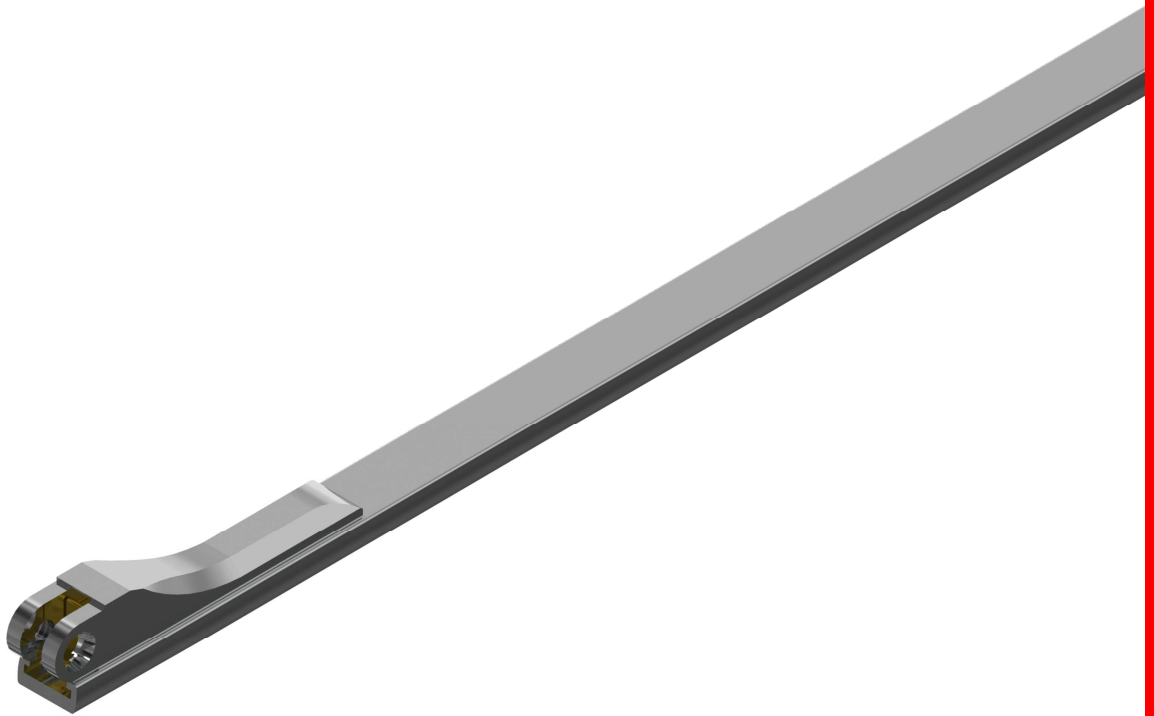

SPECIAL SPRING HINGES

C'Flex

SLIDING SPRING HINGES

60-04088

- Spring hinge with sliding mechanism
- Flat design
- Case made from nickel silver
- Ideal for titanium and aluminium temples

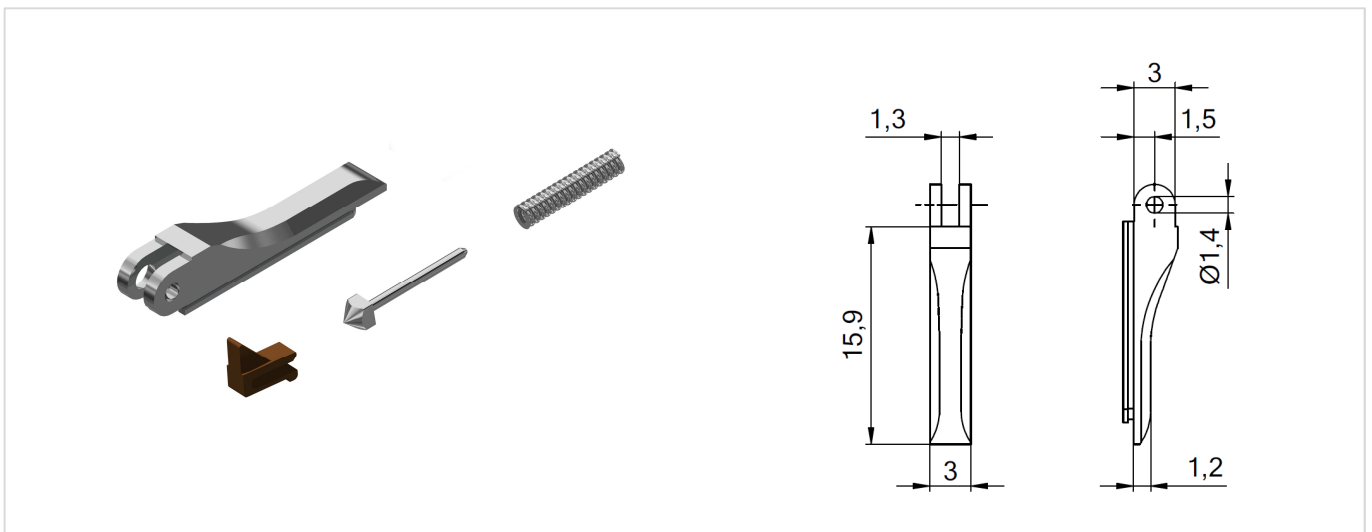

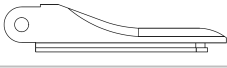
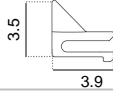
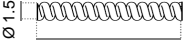
Case	Plunger	Spring bolt	Coil spring
			
60-04088.023	11-20132	11-20133.041	97-17899

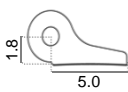
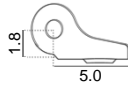
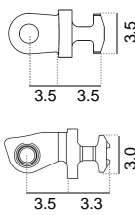
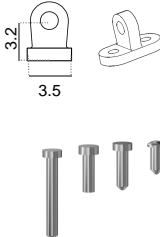
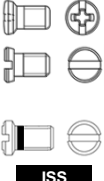
Matching parts				
Front hinges for soldering	Front hinges for welding	Front hinges for plastic frames 90°	Rivet hinges / Rivets	Screws
				
52-05101 single action	52-04266 single action titanium	33-05067 single action 33-05025 double action	51-05005 11-20247 11-20237 11-20245 11-20246	99-01813 for double action 99-02501 for double action 99-01539 for single action

