

# C'Flex

SLIDING SPRING HINGES

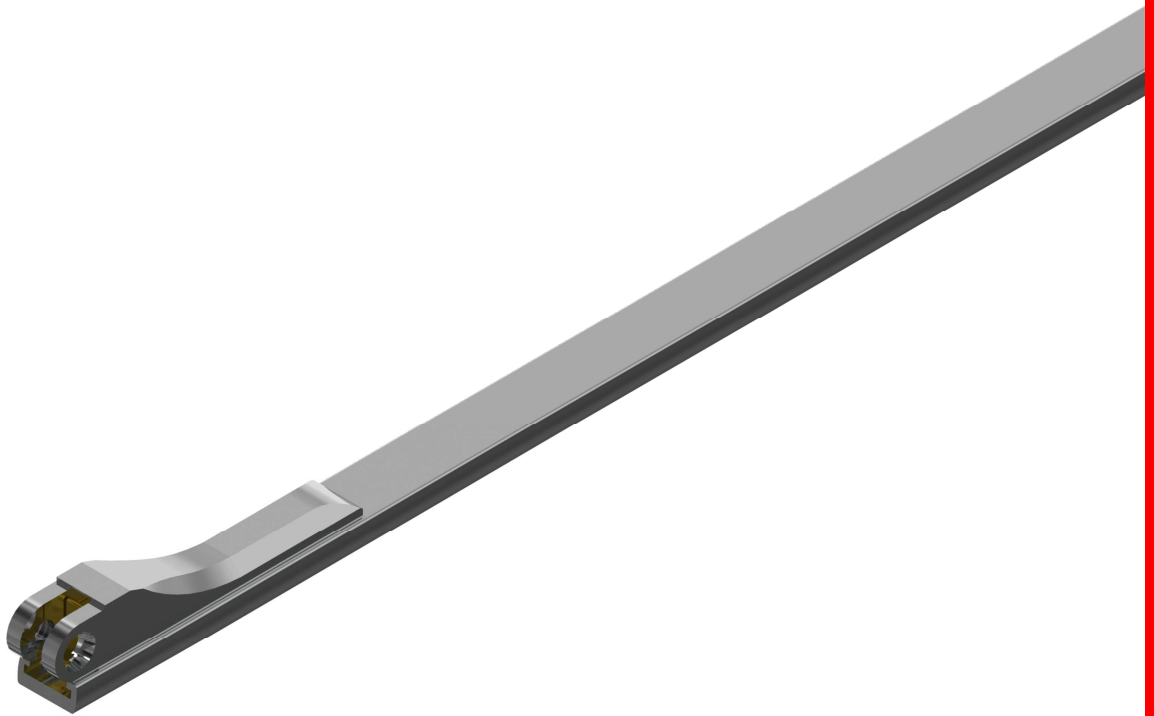

SPECIAL SPRING HINGES

# C'Flex

## SLIDING SPRING HINGES

**60-04088**

- Spring hinge with sliding mechanism
- Flat design
- Case made from nickel silver
- Ideal for titanium and aluminium temples

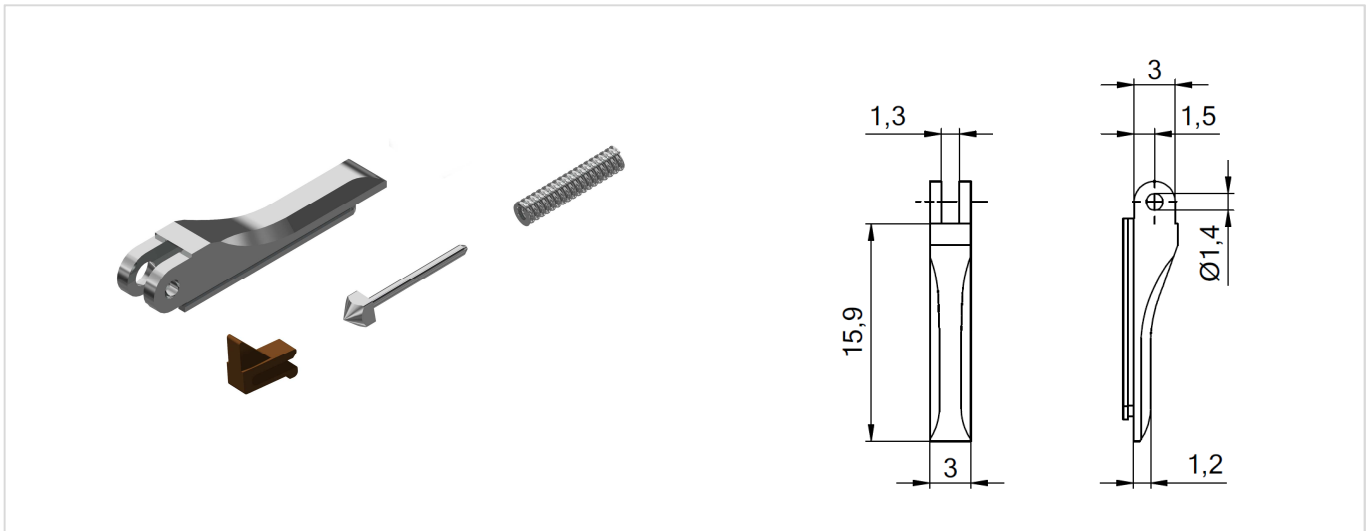

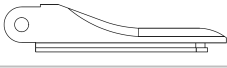
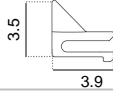
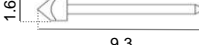
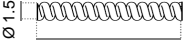
Case	Plunger	Spring bolt	Coil spring
			
17-04088	11-20132	11-20133.041	97-17899

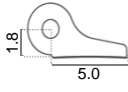
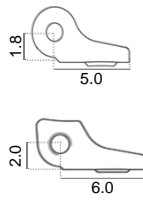
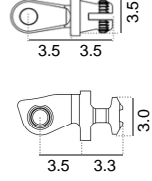
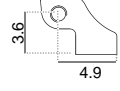
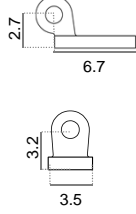
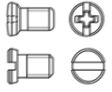
Matching parts					
Front hinges for soldering	Front hinges for welding	Front hinges for plastic frames 90°	Step hinges for soldering	Rivet hinges	Screws
					
52-05101 single action	52-04266 titanium 52-05226 double action	33-05067 single action 33-05025 double action	52-05225 double action	52-04088 51-05005	99-01813 99-02501

